APPLICATION NOTE

ECONOMIC ANALYSIS OF WIND PROJECTS

Eclareon

October 2013

Document Issue Control Sheet

Document Title:	Application Note—Economic Analysis of Wind Projects
Publication No:	Cu0191
Issue:	01
Release:	October 2013
Author(s):	Eclareon
Reviewer(s):	Bruno De Wachter

Document History

Issue	Date	Purpose
1	October 2013	Publication in the framework of the Good Practice Guide
2		
3		

Disclaimer

While this publication has been prepared with care, European Copper Institute and other contributors provide no warranty with regards to the content and shall not be liable for any direct, incidental or consequential damages that may result from the use of the information or the data contained.

Copyright© European Copper Institute.

Reproduction is authorized providing the material is unabridged and the source is acknowledged.

CONTENTS

Summary	1
Introduction.....	2
Lifecycle Cost Components and Benchmarks for a WPP	3
Lifecycle of a WPP.....	3
Total Costs of a WPP.....	5
Economic Analysis	8
Internal Rate of Return	11
Net Present Value.....	12
Payback Period	13
Levelized Cost Of Energy	14
Risk Assessment	16
Financing Alternatives	18
Conclusion	20
Annex 1: Segmentation of Wind Life Cycle Cost	21
Annex 2: Acronyms.....	23

SUMMARY

This Application Note presents and illustrates key elements associated with the economic analysis of wind energy projects and is aimed at municipalities, cooperatives, investors, and companies that want to install wind parks on their premises.

Wind investments can provide an attractive risk/return profile, as well as other potential benefits such as risk diversification and a hedge against rising fuel prices. The increasing number of Power Purchase Agreements (PPA) being closed worldwide show that in some cases wind is already cost-competitive against traditional energy sources. Electricity consumers (the offtakers) are often better off by securing a fixed long-term price for wind electricity, instead of buying electricity from the grid at an uncertain (and arguably increasing) rate.

Nevertheless, in order for wind projects to be viable, it is necessary that the business model be based on a stable scheme that enables long-term predictable revenue streams, regardless of whether it is market driven (PPA) or politically driven (FiT).

In all cases, an economic analysis of the investment opportunity is required before undertaking the project. Several financial indicators are useful for assessing the viability of the project, including IRR, NPV, and payback period, among others. Moreover, it is advised that conservative assumptions be used in the financial model and sensitivity analysis be performed to consider the impact of different scenarios on profitability.

Wind investments are generally structured with high leverage, thanks to the relatively predictable and stable nature of future cash flows. The two main financing alternatives are corporate finance and project finance. These are still in place even in the most challenging markets in the current context of global financial downturn, albeit at higher prices and with more restrictive conditions than previously.

Even though a wind energy investment is exposed to different risks (technical, legal, and financial, among others), there are many ways these risks can be reduced throughout the lifetime of the project. For instance, technology risk can be reduced by installing proven wind turbines, relying on warranties, and performing preventive maintenance.

This report is organized as follows:

- The Introduction Section provides some background for understanding the global wind market and its major trends, including the most relevant purposes for which investments are undertaken.
- The following Section provides benchmark values for life cycle costing.
- The Economic Analysis Section discusses and computes the different indicators used to measure profitability, and addresses the importance of the parameters used in the valuation process as well as sensitivity analysis.
- Finally, the last two Sections discuss risk assessment and mitigation and different financing options.

INTRODUCTION

This report explains the key aspects to determine the economic viability of wind energy projects, but it should be noted that it only relates to multi-megawatt Wind Power Parks (WPPs), since addressing the small wind sector requires a different approach than the one applied herein.

In recent years, wind energy capacity has increased significantly and is expected to maintain this increasing trend, due mainly to the following driving forces:

- **Diversification:** Wind investments provide a hedge against fuel price shocks and contribute towards energy independence from third countries.
- **Sustainability and responsibility:** Increasing environmental concerns, such as climate change, encourage the installation of clean energy sources such as wind in order to reduce emissions.
- **Profitability:** A wind project is a profitable investment for both investors and financiers, and provides a risk/return profile that in many cases is more attractive than that of other assets (e.g., equities market).

According to the Global Wind Energy Association (GWEA), the global wind market will grow 12.9%¹ per year on average from 2013 to 2017, to reach 536 GW of cumulative wind capacity in 2017. The following Figure illustrates the positive trend of the market:

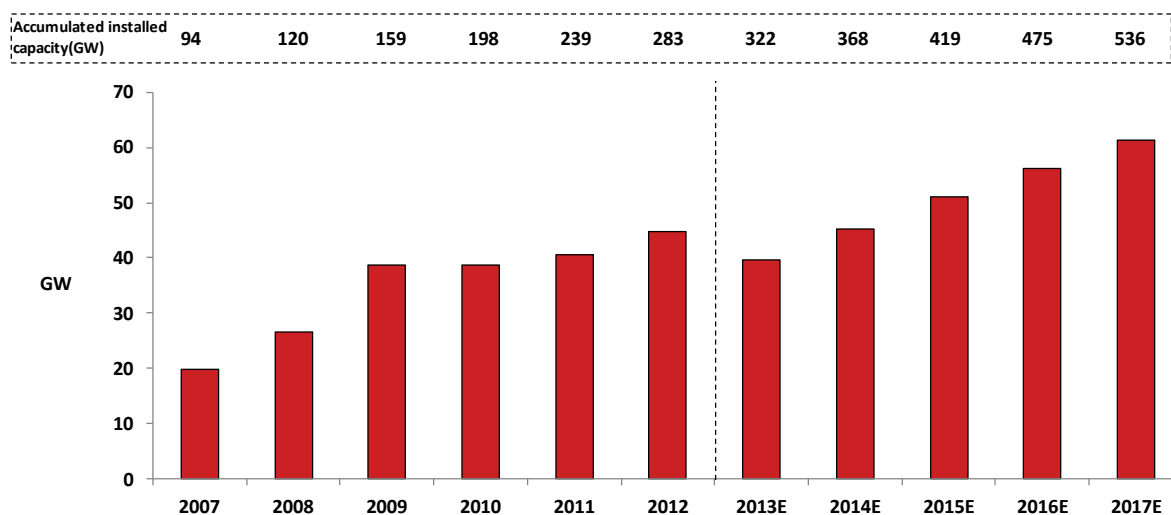

Source: GWEA; EWEA; ECLAREON analysis

Figure 1 – Global Market Historical Evolution and Forecast of Annual Installed Capacity 2007-2017

Of the above capacity, onshore installations account for the great majority (~98%), while the offshore wind only now beginning to mature.

As mentioned above, one of the market drivers of wind energy is its cost competitiveness compared to conventional energy sources. In other words, in many cases wind energy can be competitive *per se* (i.e., without any governmental support). This relatively recent phenomenon coincided with the gradual elimination

¹Compound Annual Growth Rate (CAGR)

of public incentives such as Feed-in Tariff (FiT) schemes, and with the introduction of new business models such as those based on Power Purchase Agreements (PPA).

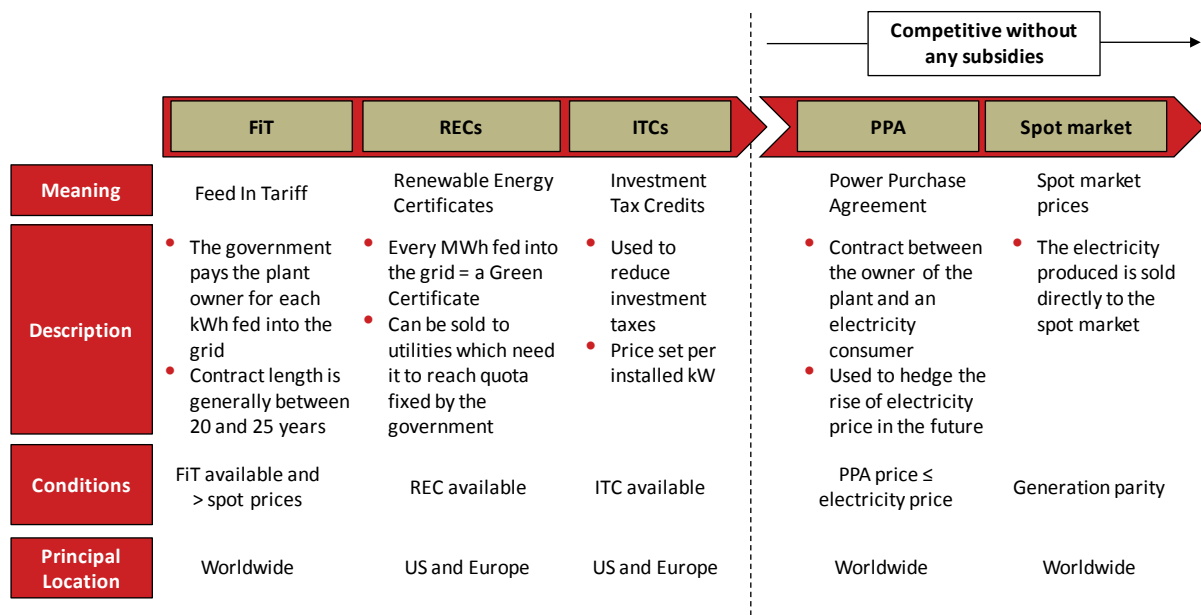

Source: ECLAREON analysis

Figure 2 – Business Model Typical Evolution

Currently, as subsidies are being reduced, revenues from wind energy projects are increasingly based on market driven contracts such as PPA rather than on incentive schemes such as FiT. Nevertheless, the development of wind energy in different countries shows that it is possible to drive the market through different models, as long as these are stable and provide predictable revenue streams.

LIFECYCLE COST COMPONENTS AND BENCHMARKS FOR A WPP

When analysing wind economics, it is relevant to consider the costs associated to each of the stages of the lifecycle of a WPP and the ways in which returns can be optimized. With this in mind, this Section includes an overview of the following main elements:

- Lifecycle stages of a wind energy project: from the initial planning to decommissioning of the park.
- Total costs of a WPP: capital investment and operating investment.

LIFECYCLE OF A WPP

The lifecycle of a WPP can be divided in three main stages:

- Project development and installation phase: this ranges from the initial planning to the end of construction, and generally requires between 6 and 8 years to be completed.
- Operation: it lasts for the entire lifetime of the wind turbine, which in general ranges from 20 to 25 years according to manufacturers.
- End of life: the decommissioning or replacement of the equipment at the end of the WPP's lifetime.

The next Figure details the activities that are usually performed during each of the main stages in the life of a wind project:

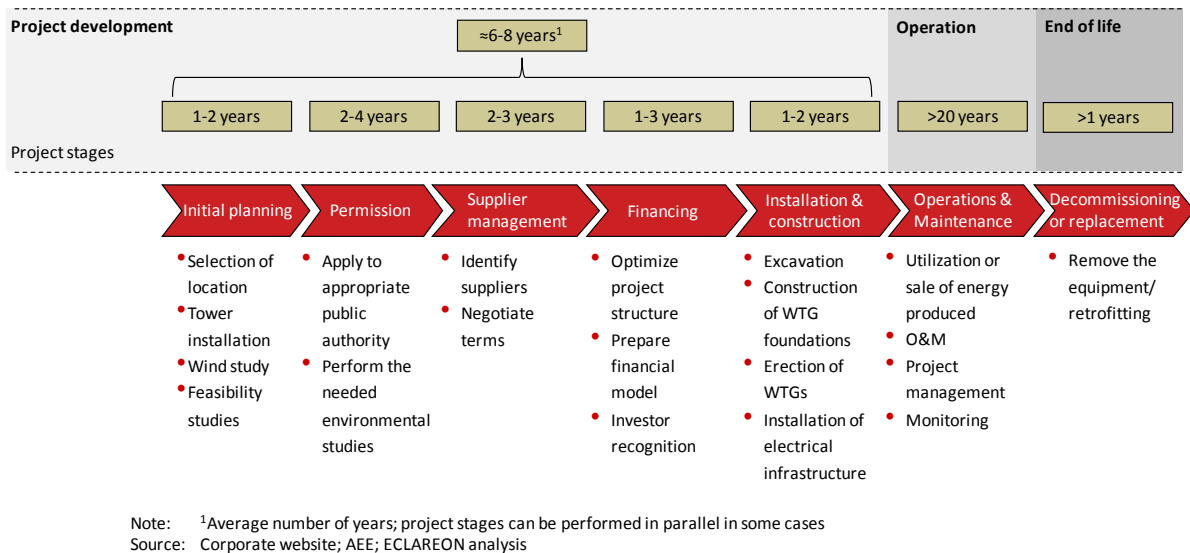

Figure 3 – Wind Project Development by Phases

To optimize electricity generation during the operation phase of a WPP, three crucial maintenance tasks are performed: preventive, predictive, and corrective maintenance.

	Preventive	Predictive	Corrective
Description	<ul style="list-style-type: none"> Preventive or routine maintenance is a schedule-based activity performed typically every six months to maintain the WPP 	<ul style="list-style-type: none"> Predictive maintenance takes action when required, and not according to a pre-fixed schedule. It aims to detect anomalies at the earliest stage possible Helps to optimize the stock of replacement components 	<ul style="list-style-type: none"> Corrective maintenance fixes detected problems
Typical tasks included	<ul style="list-style-type: none"> Change the gear oil, coolants, seals, brake pads, and filters; grease the bearings Adjust sensors and actuators Visually inspect the blades, tower, and electrical connections among other 	<ul style="list-style-type: none"> Execute maintenance tasks, visual inspections, control measurements, condition analyses, and repair works called by a high tech Condition Monitoring System (CMS) 	<ul style="list-style-type: none"> The equipment can be replaced or repaired

Source: Wind Energy Update; ECLAREON analysis

Table 1 – Description of Maintenance Tasks

Preventive and predictive maintenance jointly require ~40 hours a year per turbine, while corrective maintenance expenses vary depending on the wind turbine technology being installed: the more reliable the technology, the lower the non-routine expenses.

In this sense, the lower maintenance costs associated with certain wind turbine designs are regarded as one of their main advantages. For instance, the corrective maintenance of direct drive technologies (i.e., gearless turbines) can be less time-consuming than that of other alternatives. In spite of this dispersion, EWEA estimates that the average time requirements of corrective maintenance can be similar to those required for preventive plus predictive maintenance.

According to a study conducted by the Electric Power Research Institute (EPRI) within the power generation industry², prioritizing preventive maintenance over corrective maintenance can lead to significant annual maintenance cost reductions (the study documented an overall 47% decrease in total maintenance costs).

TOTAL COSTS OF A WPP

To assess the economic viability of a WPP, two of the most important variables³ are the Capital Expenditure (CAPEX), which is the initial investment, and the Operational Expenditure (OPEX), which is the sum of the operating costs of the plant during its life. These variables comprise the total costs associated to the WPP during its lifetime, term that is generally referred as Life Cycle Cost (LCC). The following Figure illustrates the case of an onshore WPP with geared wind turbines:

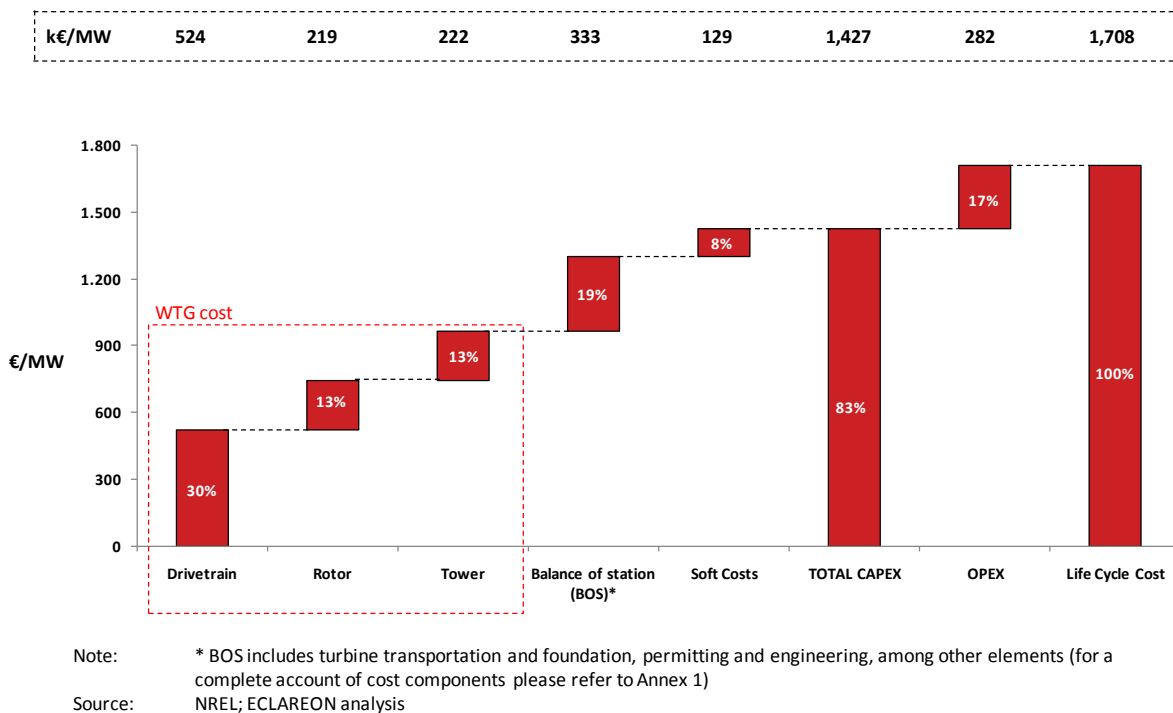

Figure 4 – Life Cycle Cost of an Onshore Installation⁴

Within the above graph, the CAPEX has been segmented in three main components:

- The Wind Turbine Generator (WTG), which is the highest cost component.
- Balance of station, which is composed of installation and structure costs.
- Soft costs, which are mainly financial costs and insurance costs during construction.

The WTG, which accounts for the largest proportion within the LCC of the wind park (~57%), is worth analysing in greater detail⁵. The next Figure shows the segmentation of the total cost of a WTG:

² Cited in 'CMMS in the Wind Industry', October 12, 2012; report prepared for Sandia National Laboratories.

³ Other key variables such as capacity factor will be discussed in a subsequent Section.

⁴ A lifetime of 20 years and an inflation rate of 2% is assumed.

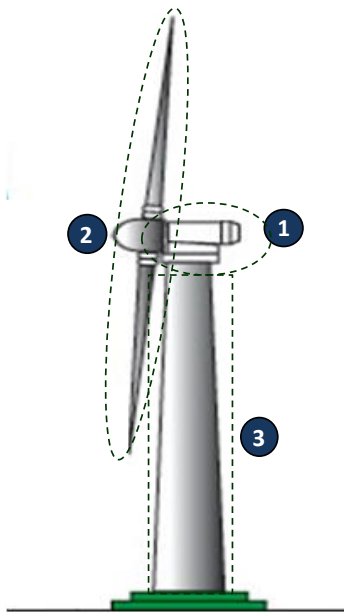

1	Drivetrain	k€/MW	%
	Gearbox	108	6.3
	Mainframe	95	5.5
	Variable-speed electronics	81	4.7
	Generator	68	4.0
	Electrical connection	57	3.3
	Low speed shaft	27	1.6
	Yaw drive and bearings	24	1.4
	Control, safety, and condition monitoring	23	1.3
	Bearings	15	0.9
	Hydraulic, cooling system	13	0.7
	Nacelle cover	12	0.7
	Mechanical brake, high-speed coupling	2	0.1
2	Rotor	k€/MW	%
	Blades	134	7.8
	Pitch mechanism and bearings	43	2.5
	Hub	40	2.3
	Spinner, nose cone	3	0.2
3	Tower	k€/MW	%
	Tower	222	13

Source: NREL; ECLAREON analysis

Figure 5 – Segmentation of Onshore WTG Costs

The estimates given above show that total CAPEX for an onshore WPP adds up to 1,427 k Euros per MW, although it can vary by up to 30% depending on variables such as WTG technology and WPP location.

Until recently, these costs have been decreasing sharply mainly due to the following reasons:

- The increase in installed capacity, which enabled economies of scale.
- Technological developments that resulted in the rise of WTG average unit capacity, taking better advantage of available space and decreasing the weight per unit power.
- The introduction of new WTG technologies into the market (such as full converter) that enable better optimization of wind resources.

As for future price trends, the European Wind Energy Association (EWEA) estimates that prices could drop 40% from 2012 to 2030, amounting to 800k Euros per MW on average in 2030.

On the other hand, operating expenses are those that are incurred over the entire lifetime of the project and can be grouped as follows:

- Operation & Maintenance costs (O&M), which represent ~60% of OPEX and tend to increase as the WPP reaches the end of its lifetime.
 - The major cost component is the maintenance of the wind turbine generator.
- Other operating costs (~40% of OPEX), including rent, taxes, and insurance.

⁵ For a complete account of cost components within wind LCC, please refer to Annex 1.

As was the case with CAPEX, OPEX have also been decreasing on average over time, mainly due to the expertise gained on O&M tasks and the increase in WTG unit capacity.

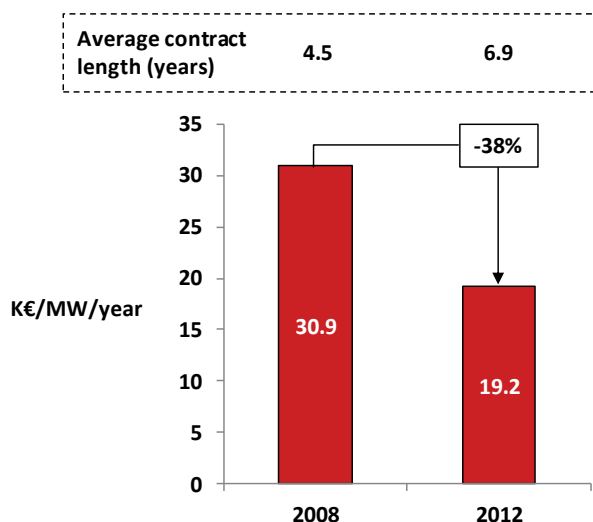

Source: Bloomberg New Energy Finance; ECLAREON research

Figure 6 – Full-Service O&M Contracts for Onshore

In the future, it is expected that in general OPEX will remain relatively unchanged at least until 2015, since the decrease in O&M costs is compensated by an increase in other operating costs such as taxes.

The benchmark values presented above correspond to an onshore WPP, and as expected, these estimates can vary substantially, depending upon the project’s location. As the following Figure shows, total LCC for an offshore wind park can more than triple that of an onshore system.

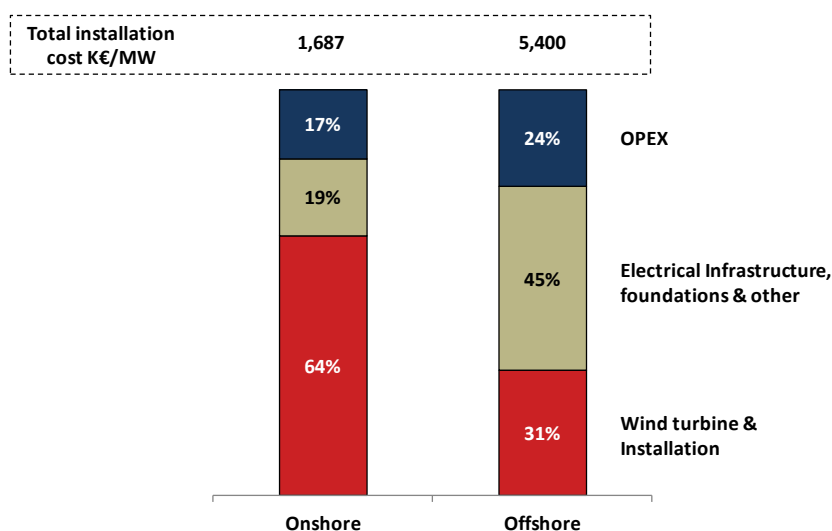

Source: NREL; Corporate website; ECLAREON research; ECLAREON analysis

Figure 7 – Offshore and Onshore LCC Segmentation

Whereas the electrical infrastructure and foundations account for nearly 20% of total onshore LCC, this component is the most relevant one for an offshore wind park, adding up to some 45% of total costs, and increasing in line with distance to shore and water depth. The following scatter graph illustrates the estimated future developments of offshore WPP in terms of distance to shore and water depth:

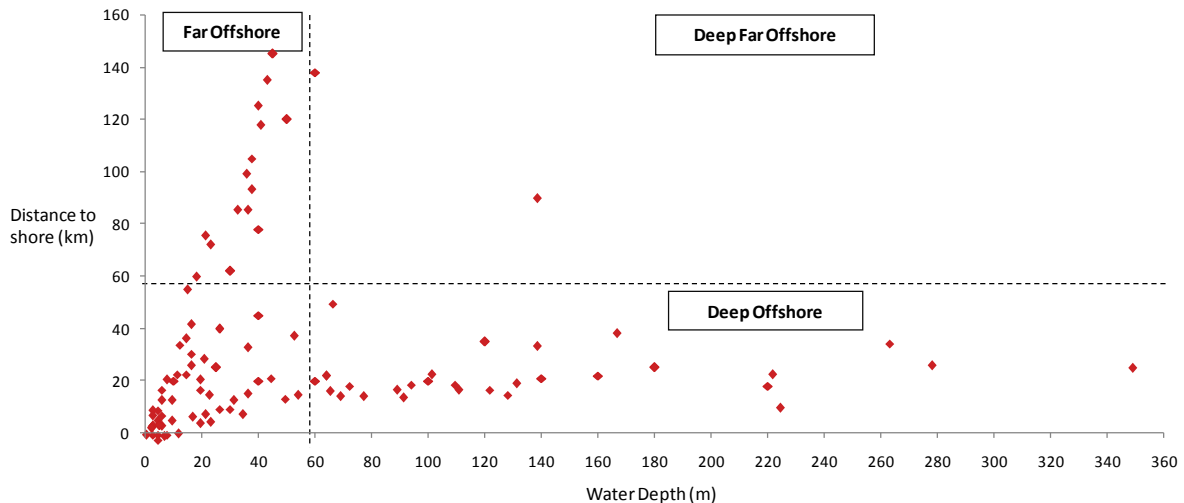

Note: The above is a sample of all offshore WPPs until 2025 (EWEA's database of offshore WPPs operating, under construction, consented, in the consenting process or proposed by developers)
 Source: EWEA; Eclareon analysis

Figure 8 – Estimation of Offshore WPPs in terms of Distance to Shore and Water Depth (year 2025)

In particular in the Northern European countries, the available technical potential of far offshore WPP in addition to the current limited availability of sites near the shore (<20 km), will result in the development of offshore WPP further away from the coast, which will cause OPEX to increase.

ECONOMIC ANALYSIS

To decide whether to invest in a wind project or not, an estimation of the economic value or profitability of the project is required, which is generally calculated with a financial model. The economic analysis process can be summarized in three steps:

- First, forecast all the costs and revenues associated to the project during its lifetime and then convert them to cash flows.
- Then, set different probable scenarios and calculate financial indicators to determine profitability.
- Finally, analyse the results from the perspective of the different holders of capital.

Special care should be taken with setting the assumptions within the analysis that have the greatest impact on profitability. These are generally related to the following parameters:

- Related to costs, CAPEX and OPEX values, which were detailed in the previous Section.
- Related to revenues, the capacity factor (or full load hours⁶) and the price received (or cost saved) for the wind electricity generated are the paramount elements.

The capacity (or load) factor of a WPP is the relation between the total amount of energy generated during a specified period and the potential amount of energy the WPP would produce if it operated at full nameplate capacity. Therefore, all else being equal, the higher the capacity factor of the WTG in a given wind park, the higher the electricity-generating potential of that WPP. Clearly, the capacity factor is always lower than 100%

⁶ Full load hours are equal to capacity factor times the number of hours in an entire year (i.e. 8,760 hours).

for any generator plant due to unavailability caused by maintenance or repair. In the case of wind power, the availability of wind also decreases capacity factor.

Over the past years, capacity factors have improved significantly, a trend that is expected to continue.

- Ten years ago, it was common to have capacity factors between 20-30%.
- Today, it is not uncommon to have wind farms with capacity factors in the range of 40-50% onshore, and even more offshore.

The above improvement is a result of the new WTG designs, which incorporated larger rotors than before for a given nominal power, a trend in wind power design especially present in the last 2 years. The following Figure shows the estimated expected capacity factor of WPPs according to NREL:

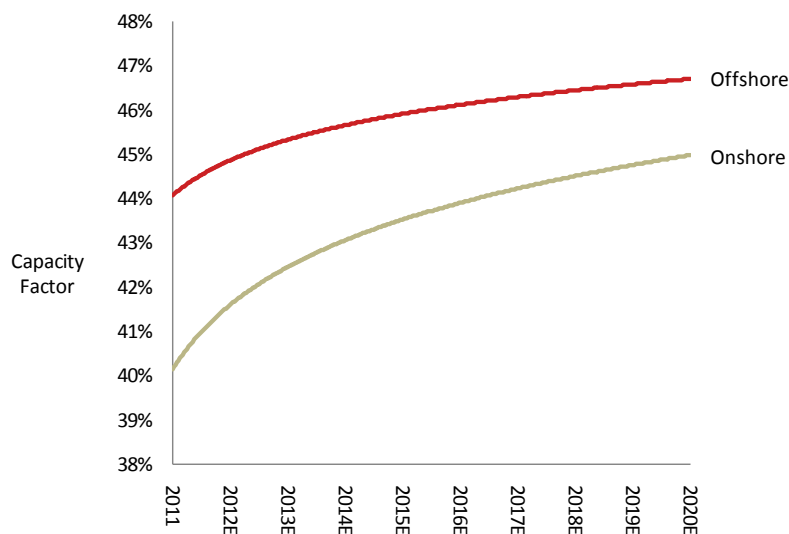

Source: NREL; Eclareon analysis

Figure 9 – Estimated Capacity Factor of Wind Parks 2011-2020E

Revenues from generated wind electricity can arise from different sources such as:

- The price received through incentive mechanisms such as FiT or market contracts such as PPA.
- The cost saved by self-consuming wind electricity instead of buying it from the utility grid (although this is most often the case of small-size wind farms, which are not being addressed in this report).

As explained in a previous Section, revenues based on FiT used to be the norm but are gradually being replaced by market driven contracts such as PPA⁷ as the market matures. Revenues from such contracts depend on several variables such as WPP characteristics (size, location, and capacity factor) and the opportunity cost (e.g., the cost of electricity from the grid). Therefore, different countries (and states within countries, as is the case of USA) operate with different revenue levels.

⁷ This was illustrated in *Figure 2: Business Model Typical Evolution*.

Although prices per kWh sold vary significantly, for the purposes of computing the economic viability of a particular wind project as required in this Section, the revenue per kWh is set here at seven Euro cents, which is considered a realistic assumption given the current prices for onshore systems⁸.

Finally, concerning the indicators used to evaluate the economics of the project, the most often used metrics⁹ are computed for a particular wind project.

- Net Present Value (NPV):
 - A positive NPV indicates that the project is profitable.
 - When choosing between alternative projects, that with the highest NPV should be undertaken.
- Internal Rate of Return (IRR):
 - An IRR higher than the cost of capital indicates that the project is profitable.
 - When choosing between alternative projects, that with the highest IRR is not necessarily the most attractive one; in this case, the NPV rule should be followed.
- Payback period:
 - All else being equal, a project is more attractive if the payback period is lower than a particular desired term.
 - This indicator should be used only in conjunction with other metrics, and using discounted cash flows results in a more accurate, albeit more time-consuming, result.
- Levelized Cost Of Energy (LCOE):
 - This metric is widely used to compare between different generation sources.
 - The lower the LCOE, the higher the return for the investor.

In order to compute the above financial indicators, assumptions were set considering conservative estimates:

Concept	Unit	Value
WPP size	MW	21
WTG size	MW	1.5
WTG technology	-	DFAG ¹⁰
Full load hours	Hours/year	2,250
Construction date	Date	2013
Investment accounting life	Years	15
WTG service life	Years	20
WACC	%	6
Leverage	%	80%
Inflation	%	2
Feed-in tariff	€/MWh	70
Tax rate (over EBIT)	%	30
Indicative CAPEX ¹¹	k€/MW	1,427

⁸ PPA prices revolve around 90 USD/MWh (although with high dispersion) and FiT in Europe range between 5 and 11 Euro cents (Source: RES Legal).

⁹ For a complete definition of these financial indicators, visit Leonardo Energy Website's Application Note on the subject (['LIFE CYCLE COSTING—THE BASICS'](#), February 2012).

¹⁰ Doubly Fed Asynchronous Generator, the most commonly used model.

¹¹ With the purchase of the WTGs, a full service warranty of 2 years is included.

Concept	Unit	Value
Indicative OPEX	€/MW/year	19,200
Working Capital Requirements	€	0 ¹²

Table 2 – WPP Characteristics and Project Assumptions

It should be noted that to evaluate the economics of the project, here it is performed from the point of view of the project in its entirety (including debt and equity holders), i.e., project cash flows and the Weighted Average Cost of Capital (WACC)¹³ is used. Overall, estimated project IRR can range from 7% to 10% while equity IRR can range from 10% to 15%.

INTERNAL RATE OF RETURN

Many investors will be interested in calculating the IRR, which is the project break-even rate of return, and as such, should be greater than the required rate of return (or cost of capital).

An analysis of the project rate of return involves several assumptions that might not hold. Therefore, in order to determine the impact on IRR of a change in the main assumptions of the financial model, three scenarios were set, each with a similar probability of occurrence:

- Base Case: it includes conservative estimates of the variables used to compute profitability.
- Low Case: it includes low range values with respect to what was previously assumed in the Base Case.
- High Case: it includes high range values with respect to the Base Case.

The set of assumptions are as follows:

Variable	Low Case	Base Case	High Case
Full load hours	2,000	2,250	2,500
OPEX (€/MW/year)	15,000	19,200	25,000
CAPEX (k€/MW)	1,300	1,427	1,550
Revenue ¹⁴ (€/MWh)	50	70	90

Table 3 – Estimates for the Sensitivity Analysis

The results below give an overall perspective of the impact of the variables analysed in the profitability of the project:

¹² Average invoice collection period and average invoice payment period are considered equal (both 45 days).

¹³ For a complete explanation on the derivation of WACC, please refer to www.thatswacc.com.

¹⁴ For the sake of simplicity, it is assumed that revenues are based on FiT.

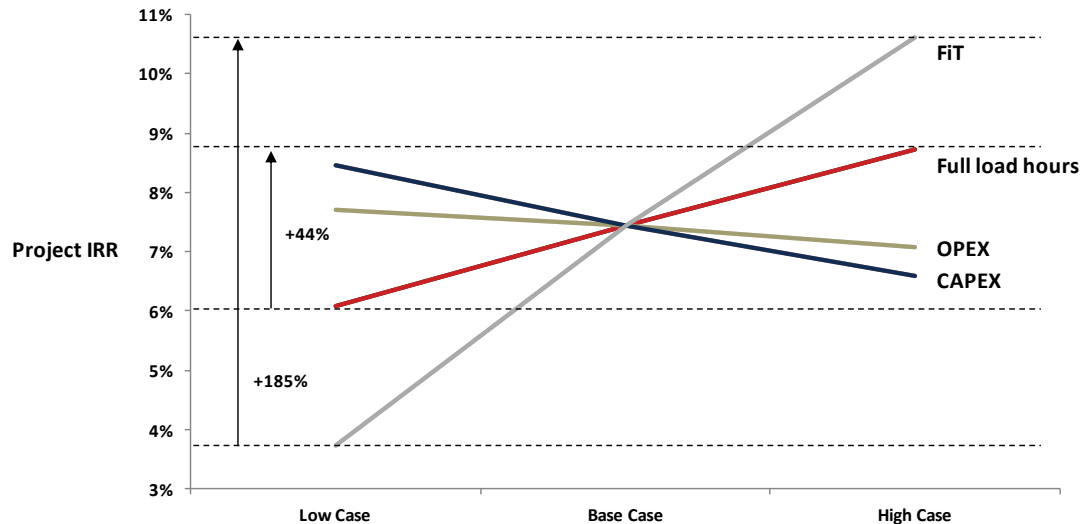

Source: ECLAREON analysis

Figure 10 – One-way Sensitivity Analysis of WPP Parameters

Considering the range of values assumed for each scenario, revenue (FiT) levels have the greatest impact on IRR of the four parameters included in the analysis. As the above Figure shows, an 80% increase in FiT (from 50 to 90 €/MWh) results in an IRR almost three times higher. In contrast, OPEX appears as the variable that influences IRR the least of the four.

NET PRESENT VALUE

Many investors also compute the NPV, which is a very popular method for computing the value generated by long-term projects, either for all the holders of the capital (equity and debt) or just for the equity holders. Here, the former will be computed.

From the previous sensitivity analysis, it was concluded that IRR varies the most as a result of a change in revenue levels per kWh. By definition, NPV and IRR are closely related, as the IRR is the rate of return that makes the NPV of the project equal to zero. Therefore, all else being equal, it can be asserted that, of the parameters included in the analysis, the revenue levels will be the variable with the greatest impact on NPV as well. Assuming a 6% WACC, the resulting NPV improves from the low case (with a negative NPV) to the high case:

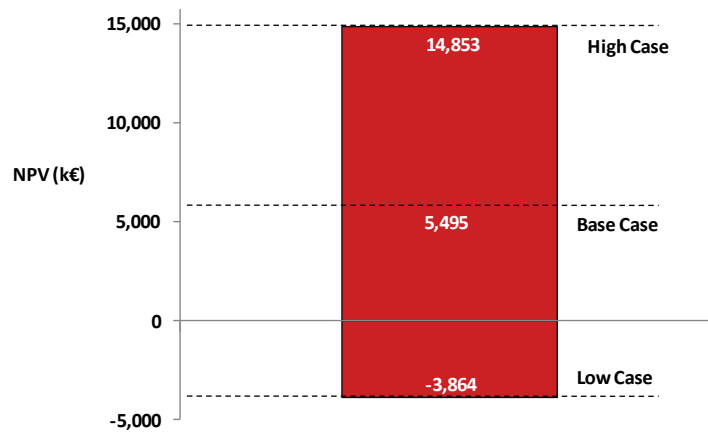

Source: Eclareon analysis

Figure 11 – NPV of the Project Depending on FiT Levels

This result shows that in the low case scenario, the project should not be undertaken, while in the base and in the high scenario, the project reaches profitability, albeit creating 2.7 times higher value in the high case than in the base case.

PAYBACK PERIOD

As opposed to the metrics computed above, the payback period does not address profitability but only gives an indication of the liquidity of the project. This tool is relatively simple to calculate and intuitive for those investors interested in knowing the time required to recover the initial investment.

Generally, the calculation of the payback period compares the undiscounted cash flows generated by the project with the investment cost, in order to provide an estimate of the length of time required to recover the investment. With this relatively simple calculation, there is no consideration of the time value of money.

A more accurate and conservative approach would consider the estimated discounted cash flows, since the undiscounted payback period is usually lower than the discounted payback period¹⁵. For the wind project used as case study in this report, both methods have been calculated and results are as follows:

- Using discounted cash flows: 16 years.
- Using undiscounted cash flows: 10 years.

The Following Figure illustrates the annual free cash flows as well as the accumulated discounted cash flows under the base case scenario:

¹⁵ That is, as long as the cost of capital is greater than 0%.

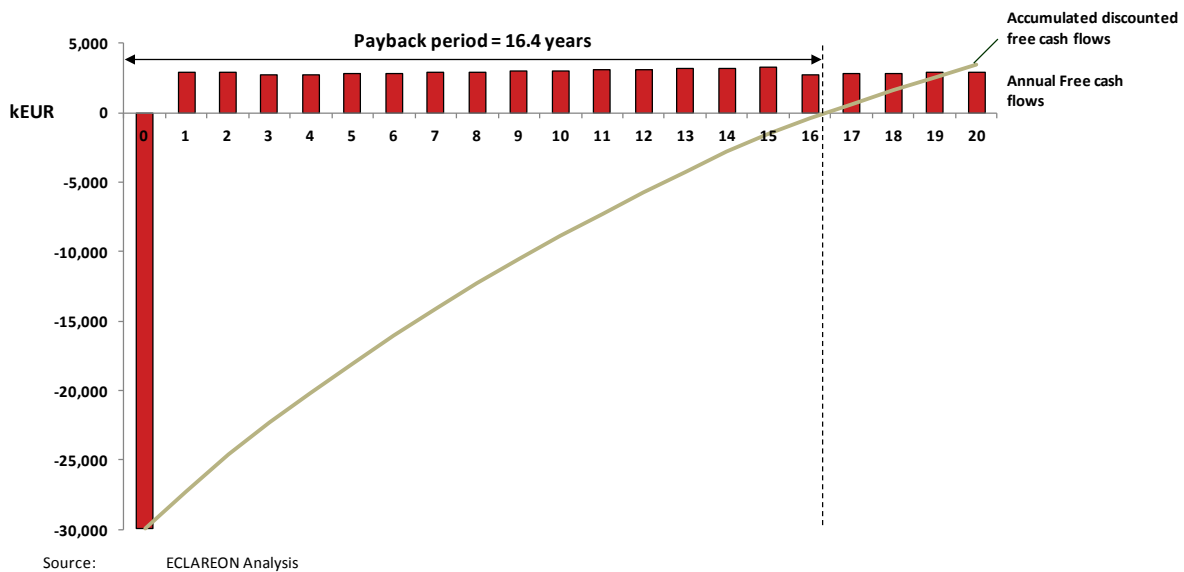

Figure 12 – Payback Period of the Base Case Scenario

LEVELIZED COST OF ENERGY

This metric is particularly useful for those investors seeking to compare different generation sources. The Levelized Cost of Energy (LCOE) can be defined as the constant and theoretical cost of generating one MWh of wind electricity, whose present value is equal to that of all the total costs associated with the wind system over its lifespan. As such, it is characterized by the following factors:

- The LCOE accounts for all costs associated with a WPP over its life, which include initial investment, O&M, and taxes, among others.
- It assumes a constant value per year and is expressed as cost per kWh.
- It incorporates total wind electricity generated over the entire lifespan of the WPP.
- It considers the return required from the investment, to discount future costs (and production) to present.

In some cases, wind is already cost-competitive compared to alternative energy sources. For instance, the recent signature of PPA contracts¹⁶ shows that certain electricity consumers (the offtakers) are better off by securing a long-term price of wind electricity rather than buying it from the grid, at an uncertain (and arguably increasing) rate.

The following Figure performs a comparison of different technologies with respect to the LCOE:

¹⁶ One example of this case is Google, which signed wind PPA contracts in order to provide its data centers with wind electricity (100.8MW in Oklahoma and 72MW in Sweden).

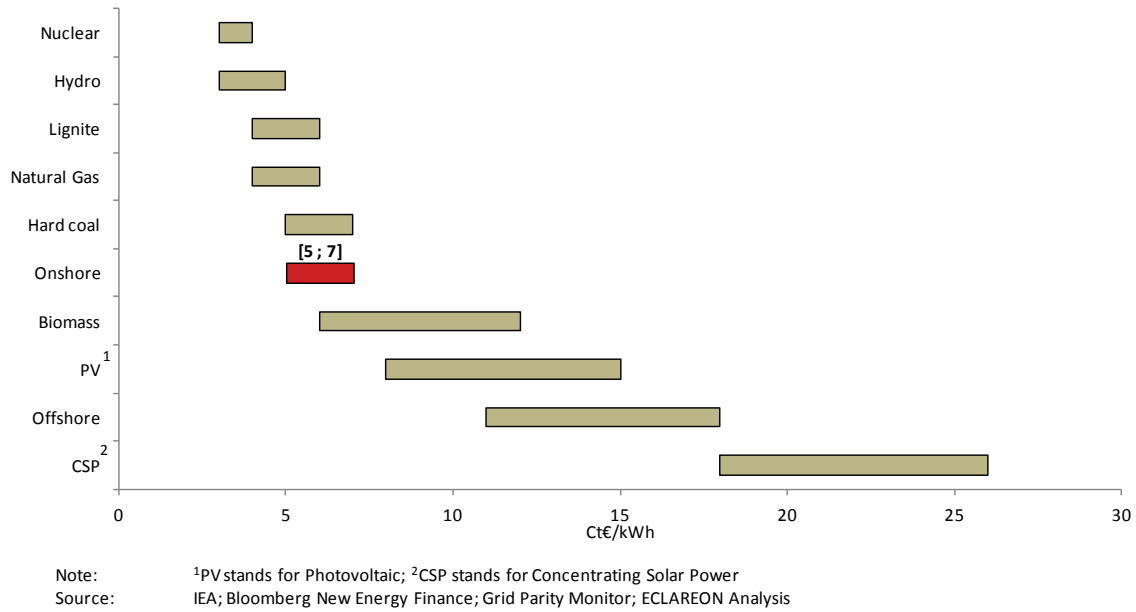

Figure 13 – LCOE Comparison (Indicative)

The above Graph should only be taken as an indication, since a case-by-case analysis is required to perform a thorough LCOE analysis, for the following reasons:

- LCOE results are highly sensitive to assumptions.
- Assumptions should be consistent across technologies.

In order to analyse the impact that the different parameters have on the LCOE, a sensitivity analysis was performed according to 3 different scenarios:

- Base Case: it includes conservative estimates of the variables used to compute profitability.
- Low Case: it includes low range values with respect to what was previously assumed in the Base Case.
- High Case: it includes high range values with respect to the Base Case.

Variable	Low Case	Base Case	High Case
Full load hours	2,000	2,250	2,500
Discount Rate	4%	6%	8%
CAPEX (k€/MW)	1,300	1,427	1,800

Table 4 – Estimates for the Sensitivity Analysis

The results are as follows:

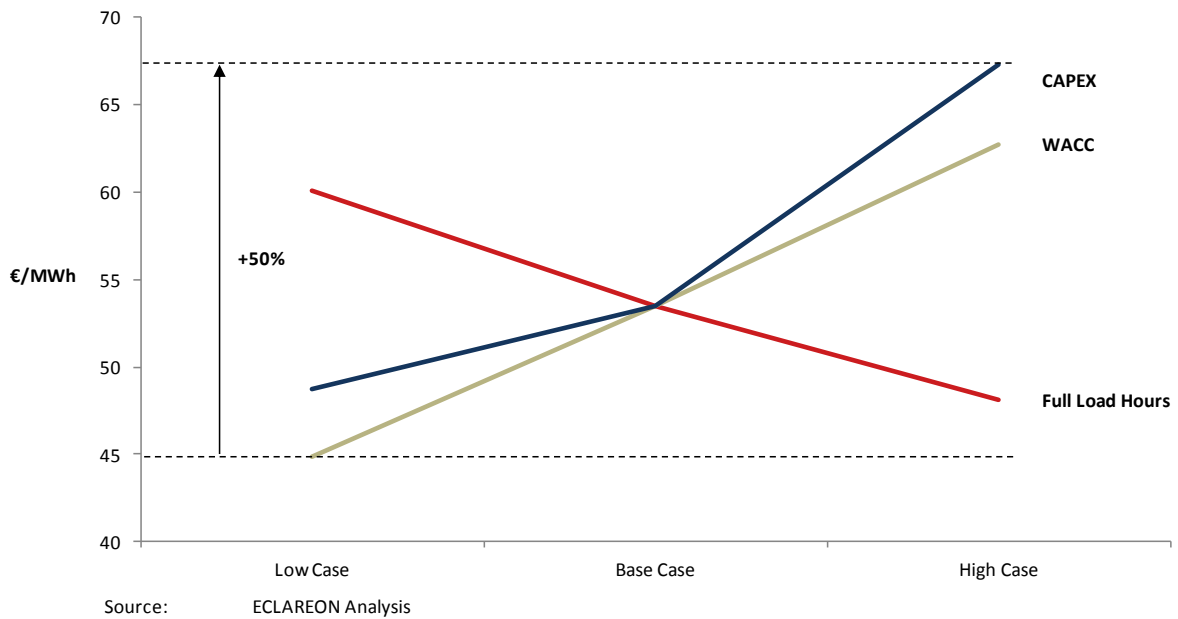

Figure 14 – One-way Sensitivity Analysis of Three Parameters on Onshore Wind LCOE

The above illustration shows that the parameters used in the financial model have a significant impact on LCOE: considering the assumptions made, LCOE can be 50% higher in the most pessimistic scenario when compared to the most optimistic one.

Two trends have been mentioned in previous Sections that will invariably result in a lower wind LCOE in the future:

- Lower CAPEX as a result of lower WTG costs.
- Higher capacity factor that will result in greater output efficiency.

RISK ASSESSMENT

Wind projects are not risk-free. Throughout a project's life cycle, it is exposed to political, financial, technological, and other risks. The main risks are identified in the following Figure:

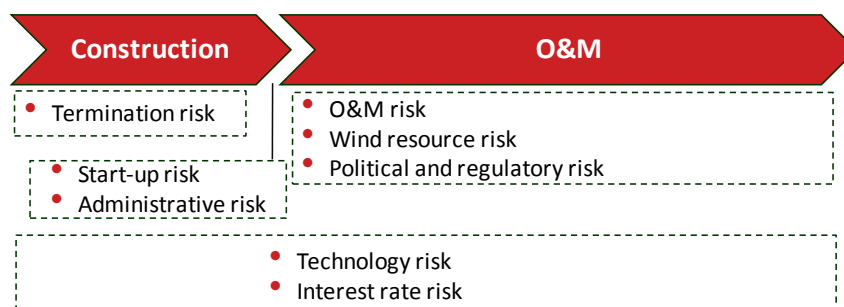

Source: ECLAREON analysis

Figure 15 – Main Risks of a Wind Project

The *technology risk* is the risk of inherent technological failures. It will depend on the WTG technology installed. The technology risk is one of the most important, as it can have a highly negative influence on both

the start-up and O&M risks. By installing proven technologies, relying on warranties, and performing predictive maintenance, technology risk can be reduced.

The following Figure shows the average downtime per component during failure and the frequency of failures.

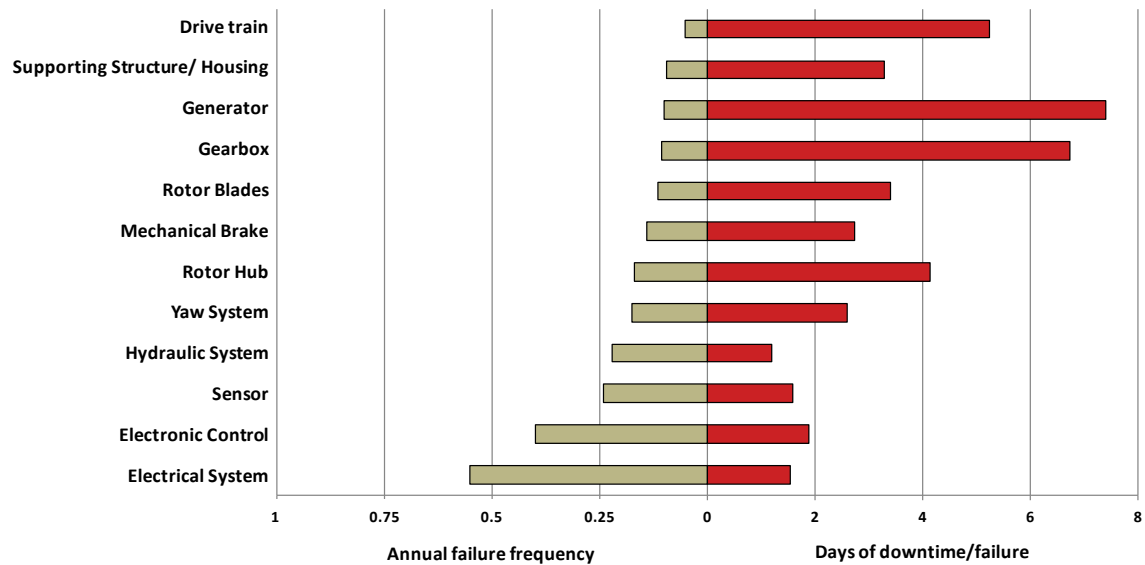

Source: ISET;IWET; ECLAREON research; ECLAREON analysis

Figure 16 – Component Reliability and Downtime Average

As the above Figure illustrates, when the gearbox or generator fails, the turbine is out of service for a relatively long period while these components are being repaired. This is downtime that negatively affects project profitability.

In conclusion, all risks should be identified, quantified, and mitigated to seek to ensure the profitability of the project. The overall risks within a wind power project and mitigation examples are summarized in the following Table:

Risks	Main mitigation
Construction and start-up risks	<ul style="list-style-type: none"> • Turnkey contract with closed price and terms • Viability of the project developer • Delivery warranty • Insurance coverage
Administrative risks	<ul style="list-style-type: none"> • Turnkey contract with closed price and terms • Viability of the project developer • Legal advice
Political and regulatory risk	<ul style="list-style-type: none"> • Stable regulatory framework • Insurance coverage
Technology risk	<ul style="list-style-type: none"> • Warranties • Installing proven technologies
Wind resource risk	<ul style="list-style-type: none"> • Historical data • Resource analysis with probabilities
O&M risk	<ul style="list-style-type: none"> • O&M contract with guarantees and penalties
Interest rate risk	<ul style="list-style-type: none"> • Fixed interest rates through contracts

Source: ECLAREON analysis

Table 5 – Risk and Mitigation Examples

Apart from the above examples, there are other mechanisms to reduce risk, which are paramount for the success of the investment:

- Setting conservative assumptions in the financial model of variables such as:
 - Inflation estimates
 - Operating expenses
 - Revenue estimates
- Performing sensitivity analysis of parameters such as the ones mentioned above.

FINANCING ALTERNATIVES

Wind energy projects are generally structured with high leverage, thanks to the relatively predictable and stable nature of future cash flows. However, the global financial crisis and the current uncertainty in certain markets have led to some changes in the financing of renewable energy projects:

- Financing conditions have tightened (including leverage, margins, and covenants, among others).
- Financial institutions are more risk-averse.

There are two main long-term financing alternatives for a multi-megawatt WPP: corporate loan or project finance.

Corporate Loan

- Financial institutions lend capital on the basis of the creditworthiness of the company or the investor.
 - As such, the bank is unlikely to be affected by a hypothetical insolvency of the project, since it is the company or the investor who backs up the loan.
- The borrowed capital generally ranges between 50-100% of the total investment (leverage rate).

- In contrast to project finance, it is not necessary for the financial institution to perform a Project Due-Diligence; it is only required that the consolidated financial statements of the parent company be analysed.
- The cost of financing varies depending on the tenor, the characteristics of the borrower, et cetera.
 - Currently in Spain, it is not uncommon to find costs of Euribor (6 months) + 400-450 bps.¹⁷

Project Finance

- Project financing relies only on the cash flows generated by the project in order to repay the loan, not on other assets the borrower may possess.
 - The project by itself must be able to guarantee the repayment of debt even under negative scenarios.
- Financial institutions lend capital to a Special Purpose Vehicle (SPV).
- For this lack of recourse to the parent company, project financing is more expensive than corporate financing.
 - Currently in Spain, it costs approximately Euribor (6 months) + 400-500 bps, while in countries such as UK or France it is at Euribor + 250-300 bps.
- Leverage under project finance ranges between 70-80%, depending on the project and the country.

Project finance consists of several stages, within which the pre-financial stage is the most critical one since it will determine if the project will be financed or not.

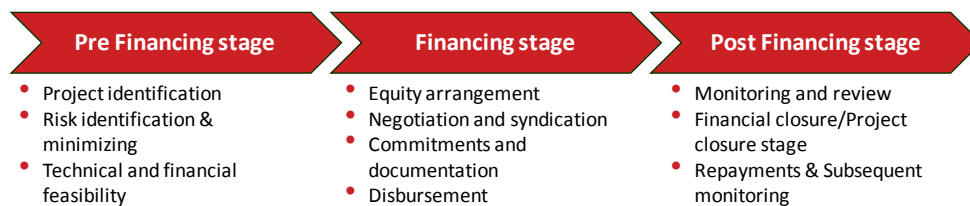

Source: Corporate website; ECLAREON analysis

Figure 17 – Project Finance Stages

¹⁷ A fixed rate of interest generally measured in basis points (100 bps are equivalent to 1%) is charged on top of a variable rate, in this case Euribor (Euro Interbank Offered Rate)

CONCLUSION

The following principal conclusions can be drawn from this report:

- Wind investments can provide an attractive risk/return profile, as well as other potential benefits such as risk diversification and a hedge against rising fuel prices.
 - For instance, it is currently more profitable for some electricity consumers to secure a fixed long-term price for wind electricity through a PPA, rather than buying electricity from the grid.
- Nevertheless, in order for wind projects to be viable, it is necessary that the business model be based on a stable scheme that enables long-term predictable revenue streams, regardless of whether it is market driven (PPA) or politically driven (FiT).
- In all cases, an economic analysis of the investment opportunity is required before undertaking the project.
 - Several financial indicators are useful for assessing the viability of the project, such as IRR, NPV, and payback period.
 - It is advised that conservative assumptions be used in the financial model and sensitivity analysis be performed in order to consider the impact of different scenarios on profitability.
- The predictable and stable cash flows of wind projects allow investors to benefit from high leverage, mainly through corporate financing or project financing.
 - These financing alternatives are still in place even in the most challenging markets in the current context of global financial downturn, albeit at higher prices and with more restrictive conditions than before.
- Finally, even though a wind energy investment is exposed to different risks throughout the lifetime of the project, there are many ways in which these risks (technical, legal, and financial, among others) can be reduced.
 - For instance, technology risk can be reduced by installing proven wind turbines, relying on warranties, and performing preventive maintenance.

ANNEX 1: SEGMENTATION OF WIND LIFE CYCLE COST

Onshore LCC		
<i>Concept</i>	<i>Values</i>	
	<u>k€/MW</u>	<u>%</u>
Wind Turbine Generator		
Rotor		
Blades	134	14%
Pitch mechanism and bearings	43	4%
Hub	40	4%
Spinner, nose cone	3	0%
Drivetrain		
Gearbox	108	11%
Mainframe	95	10%
Variable-speed electronics	81	8%
Generator	68	7%
Electrical connection	57	6%
Low-speed shaft	27	3%
Yaw drive and bearings	24	2%
Control, safety, and condition monitoring	23	2%
Bearings	15	2%
Hydraulic, cooling system	13	1%
Nacelle cover	12	1%
Mechanical brake, high-speed coupling	2	0%
Tower		
Tower	<u>222</u>	<u>23%</u>
Total	965	100%
Balance of station		
Medium-voltage electrical material	57	17%
Turbine foundation	51	15%
Turbine transportation	47	14%
Turbine erection	44	13%
Access road and site improvement	32	9%
Collector substation	20	6%
Medium-voltage electrical installation	19	6%
Development	19	6%
Transmission line and interconnection	16	5%
Project management	13	4%
Engineering	5	2%
access road and site improvement	4	1%
Site compound and security	4	1%
Control and O&M building	3	1%
Permitting	<u>1</u>	<u>0%</u>
Total	333	100%
Soft Costs		
Contingency	84	65%
Construction finance	<u>45</u>	<u>35%</u>
Total	129	100%
Total CAPEX	1,427	

Table 6 – Segmentation of Onshore Wind LCC

Offshore LCC		
<i>Concept</i>	<i>Values</i>	
	<u>Euros</u>	<u>%</u>
Wind Turbine Generator		
WTG	<u>1,342</u>	<u>100%</u>
Total	1,342	100%
Balance of station		
Transportation and installation	832	38%
Support structure	766	35%
Electrical infrastructure	405	19%
Project management	88	4%
Port and staging	55	3%
Development	<u>44</u>	<u>2%</u>
Total	2,189	100%
Soft Costs		
Contingency	353	53%
Surety bond (decommissioning)	124	18%
Financing costs	122	18%
Insurance	<u>71</u>	<u>11%</u>
Total	670	100%
Total CAPEX	4,200	

Table 7 – Segmentation of Offshore Wind LCC

ANNEX 2: ACRONYMS

Acronym	Meaning
BPS	Basis Points
CAGR	Compound Annual Growth Rate
CAPEX	Capital Expenditure
CMS	Condition Monitoring System
DFAG	Doubly Fed Asynchronous Generator
EBIT	Earnings Before Interest and Taxes
EPC	Engineering, Procurement and Construction
EPRI	Electric Power Research Institute
EU	European Union
EURIBOR	European Interbank Overnight Rate
EWEA	European Wind Energy Association
FIT	Feed In Tariff
GWEA	Global Wind Energy Association
IRR	Internal Rate of Return
kWh	Kilo Watt Hour
LCC	Life Cycle Cost
LCOE	Levelized Cost of Energy
NPV	Net Present Value
NREL	National Renewable Energy Laboratory
MW	Mega Watt
MWh	Mega Watt Hour
O&M	Operation & Maintenance
OPEX	Operational Expenses
PPA	Power Purchase Agreement
ROE	Return On Equity
SPV	Special Purpose Vehicle
WACC	Weighted Average Cost of Capital
WPP	Wind Power Park
WTG	Wind Turbine Generator